

# CARGO HANDLING & PROTECTION SOLUTIONS

BLOCKING, BRACING AND CARGO CONTROL FOR CONTAINERS, FLATRACKS, TRAILERS AND FLATBEDS

COIL RACKS/RUBBER PADS

CARGO (LOAD) BARS

DECKING/SHORING BEAMS

BLOCKING/BRACING ATTACHMENTS

SHORT LINK AND CHAIN BINDERS

FLATBED WINCHES, WINCH BARS  
AND TRACKS

FLATBED WINCH STRAPS AND  
CORNER PROTECTORS

TRAILER LOGISTIC STRAPS  
(RATCHET, CAMBUCKLE AND  
TIE-OFFS)



## WHY CHOOSE BUFFERS?

- THE INDUSTRY'S MOST COMPREHENSIVE LINE OF CARGO CONTROL SOLUTIONS.
- HIGH QUALITY, HEAVY-DUTY DESIGN AND CONSTRUCTION.
- ONE SOURCE ORDERING FOR ALL YOUR NEEDS MEANS LESS PAPERWORK.
- FAST, IN-STOCK DELIVERY FROM 3 WAREHOUSE LOCATIONS.
- DISTRIBUTOR NETWORK THROUGHOUT NORTH AND SOUTH AMERICA AND MEXICO.
- FRIENDLY, KNOWLEDGEABLE CUSTOMER SERVICE.



Securing Your Containers. Protecting Your Cargo  
*At Sea. Over Land. On Rail.*

# COIL RACKS/RUBBER PADS

## MODEL 2908-6347

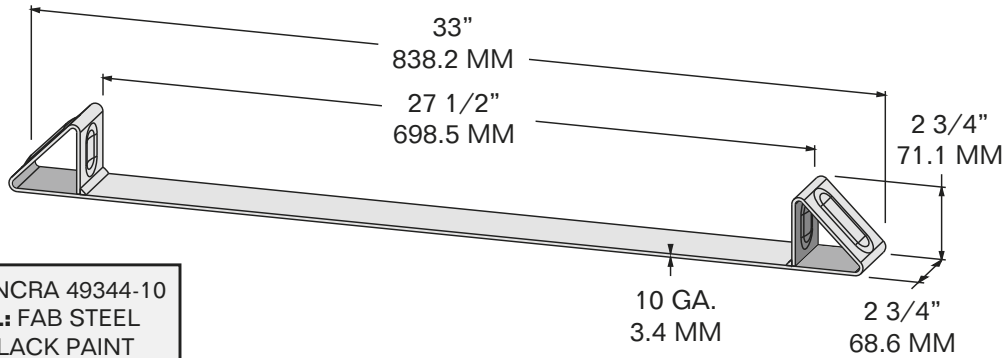

**SUB FOR:** ANCRA 49344-10  
**MATERIAL:** FAB STEEL  
**FINISH:** BLACK PAINT  
**WEIGHT:** 4.5 LBS / 2.05 Kg

## MODEL 2908-6348

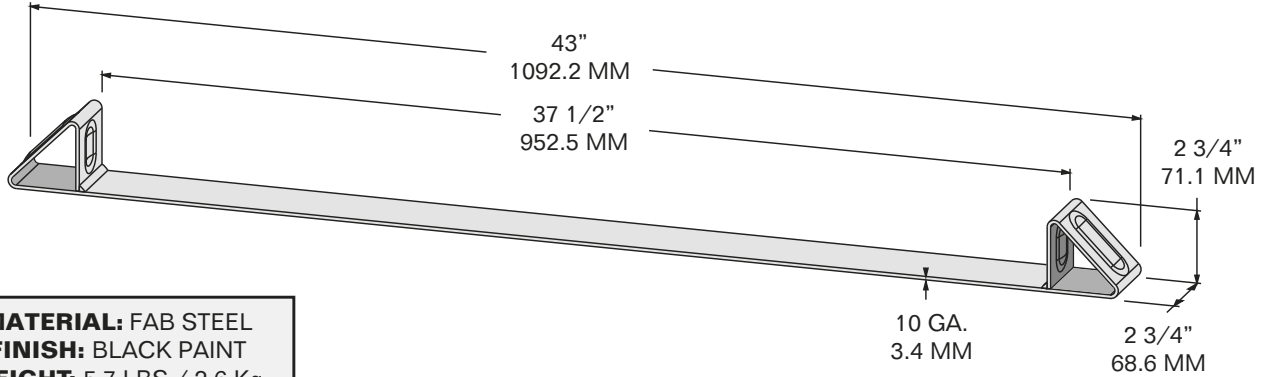

**MATERIAL:** FAB STEEL  
**FINISH:** BLACK PAINT  
**WEIGHT:** 5.7 LBS / 2.6 Kg

## MODEL 2908-6350

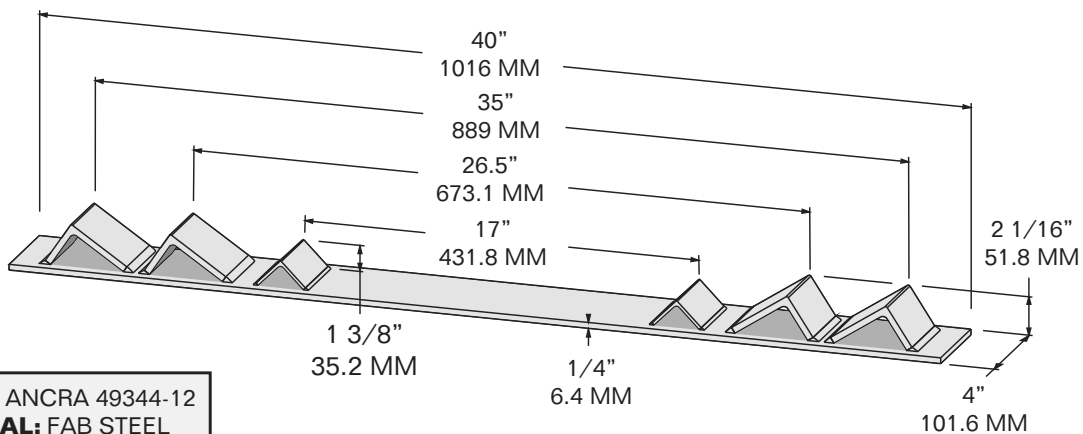

**SUB FOR:** ANCRA 49344-12  
**MATERIAL:** FAB STEEL  
**FINISH:** BLACK PAINT  
**WEIGHT:** 15.5 LBS / 7.0 Kg

# CARGO (LOAD) BARS

## OVER CENTER TYPE CARGO BAR

**MODEL 2908-2747**

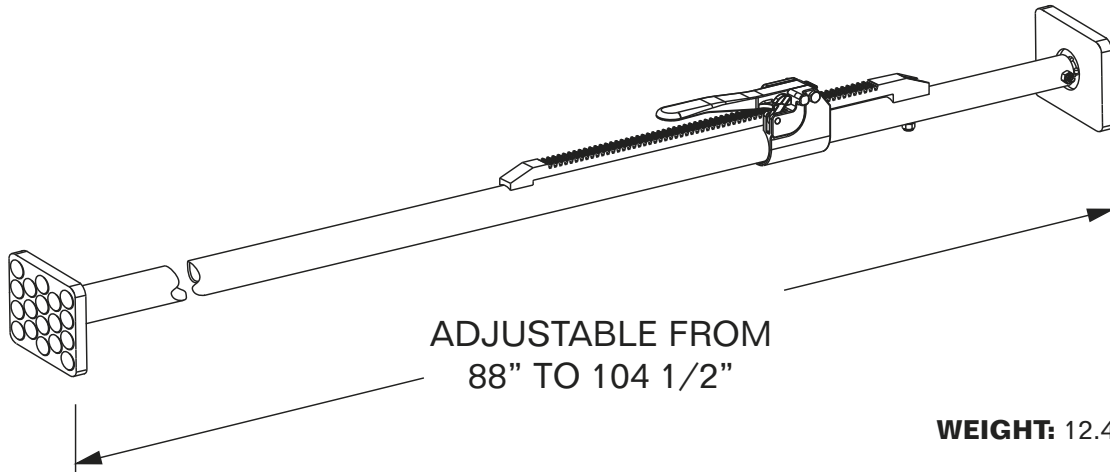

**OVER CENTER TYPE HANDLE  
SWIVEL TYPE FEET WITH REINFORCED NON-MARKING RUBBER ENDS PADS  
RUGGED DUCTILE IRON HANDLE AND HOUSING  
ZINC PLATED RODS**

## JACK TYPE CARGO BAR

**MODEL 2908-2899**

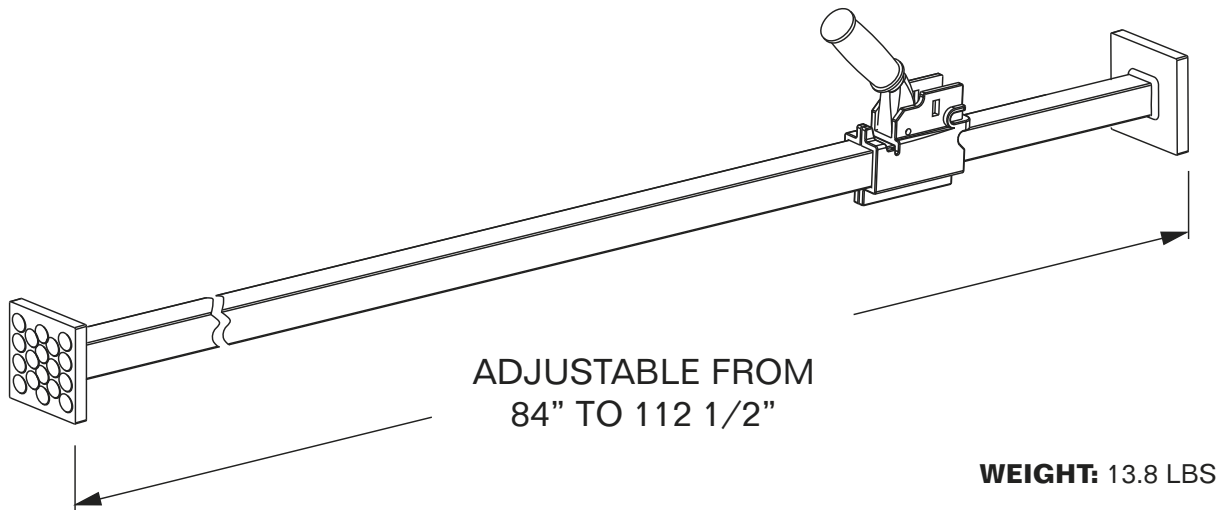

**JACK TYPE HANDLE  
RIGID TYPE FEET WITH REINFORCED NON-MARKING RUBBER ENDS PADS  
RUGGED FABRICATED SQUARE TUBING CONSTRUCTION  
ZINC PLATED RODS**

# SHORT LINK CHAIN

## SHORT LINK CHAIN



ALL CHAIN PER NACM96 SPECIFICATIONS  
(NOT FOR LIFTING)

OTHER SIZES AVAILABLE AS SPECIAL ORDER

MODEL	CHAIN DIA	GRADE	FINISH	WORKING LOAD LIMIT	WEIGHT PER FT	FT PER DRUM
2901-5/16GR70NACM96	5/16"	GRADE 70 TRANSPORT	YELLOW ZINC	4,700 LBS	1.15 LBS/.52 Kg	550 FT
2901-3/8GR43NACM96	3/8"	GRADE 43 HIGH TEST	SELF COLORED	5,400 LBS	1.40 LBS/.64 Kg	400 FT
2901-3/8GR70NACM96	3/8"	GRADE 70 TRANSPORT	YELLOW ZINC	6,600 LBS	1.43 LBS/.65 Kg	400 FT
2901-1/2GR70NACM96	1/2"	GRADE 70 TRANSPORT	YELLOW ZINC	11,300 LBS	2.64 LBS/1.2 Kg	100 FT

## CHAIN ASSEMBLIES

CHAIN ASSEMBLY LENGTHS MEASURED FROM INSIDE THE HOOKS AS SHOWN

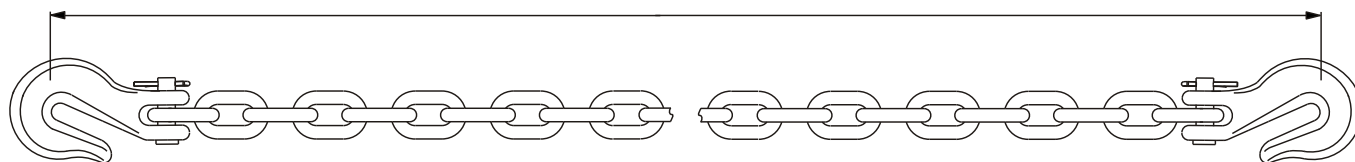

ALL CHAIN PER NACM96 SPECIFICATIONS  
(NOT FOR LIFTING)

CLEVIS GRAB HOOKS ARE STANDARD ON CHAIN ASSEMBLIES. EYE HOOKS AVAILABLE AS SPECIAL ORDER

MODEL	CHAIN DIA	GRADE	FINISH	LENGTH	WORKING LOAD LIMIT	WEIGHT PER PC	PCS PER DRUM
2901-5/16X20HHGR70	5/16"	GRADE 70 TRANSPORT	YELLOW ZINC	20 FT	4,700 LBS	23.2 LBS/10.5 Kg	25 PCS
2901-5/16X25HHGR70	5/16"	GRADE 70 TRANSPORT	YELLOW ZINC	25 FT	4,700 LBS	28.7 LBS/13.0 Kg	20 PCS
2901-3/8X20HHGR43	3/8"	GRADE 43 HIGH TEST	SELF COLOR	20 FT	5,400 LBS	33.0 LBS/14.9 Kg	20 PCS
2901-3/8X20HHGR70	3/8"	GRADE 70 TRANSPORT	YELLOW ZINC	20 FT	6,600 LBS	31.3 LBS/14.2 Kg	20 PCS

## CLEVIS GRAB HOOKS

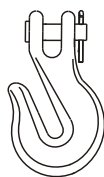

MODEL	FOR CHAIN DIA	GRADE	FINISH	WORKING LOAD LIMIT	WEIGHT PER PC
2901-5/16GHGR70	5/16"	GRADE 70 TRANSPORT	YELLOW ZINC	4,700 LBS	0.75 LBS/.34 Kg
2901-3/8GHGR43	3/8"	GRADE 43 HIGH TEST	SELF-COLOR	5,400 LBS	1.04 LBS/.47 Kg
2901-3/8GHGR70	3/8"	GRADE 70 TRANSPORT	YELLOW ZINC	6,600 LBS	1.10 LBS/.49 Kg
2901-1/2GHGR70	1/2"	GRADE 70 TRANSPORT	YELLOW ZINC	12,000 LBS	2.10 LBS/.95 Kg



# FLATBED WINCHES

## MODEL 2903-2691

WELD ON

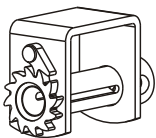

STANDARD

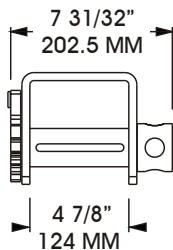
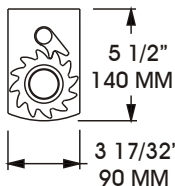

## MODEL 2903-2692

WELD ON

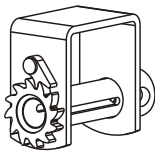

STORAGE

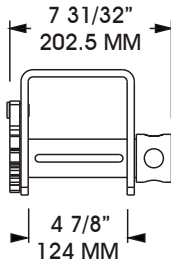
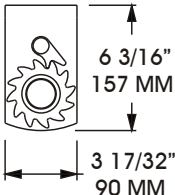

## MODEL 2903-2693

WELD ON

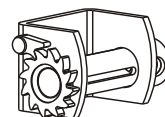

SIDE MOUNT

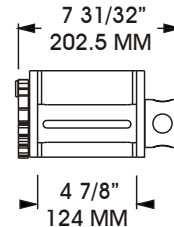
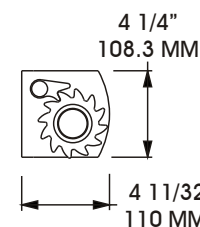

SUB FOR: ANCRA 43563-10,  
KINEDYNE 1820, MULTIPRENS 1160

SUB FOR: ANCRA 43573-10, KINEDYNE 1820S

SUB FOR: ANCRA 43579-20,  
KINEDYNE 7820, MULTIPRENS 1165

## MODEL 2903-2694

BOLT ON

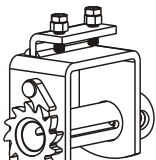

STANDARD

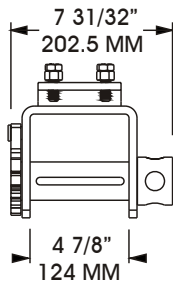
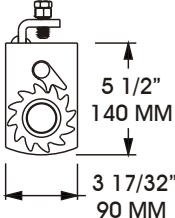

## MODEL 2903-2695

BOLT ON

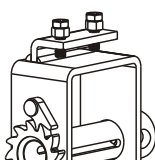

STORAGE

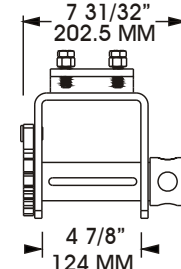
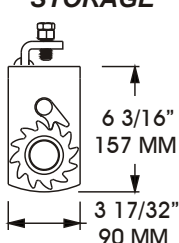

## MODEL 2903-2696

BOLT ON

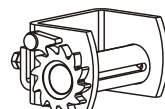

SIDE MOUNT

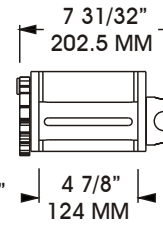
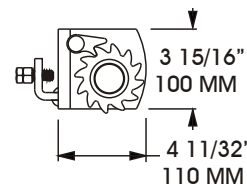

SUB FOR: ANCRA 43564-14,  
KINEDYNE 1820 P2, MULTIPRENS 1660

SUB FOR: ANCRA 43564-12

SUB FOR: ANCRA 43564-16,  
KINEDYNE 7820 P2, MULTIPRENS 1665

## MODEL 2903-2697

SLIDER

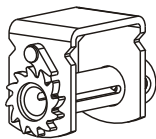

STANDARD

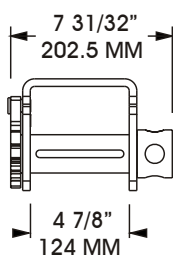
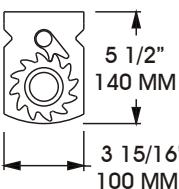

## MODEL 2903-2698

SLIDER

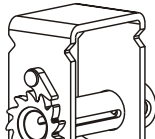

STORAGE

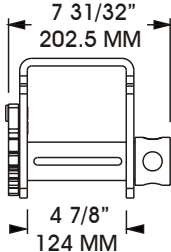
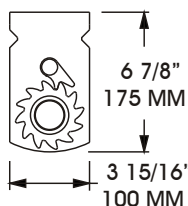

## MODEL 2903-2699

SLIDER

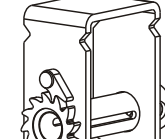

DEEP STORAGE

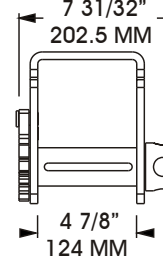
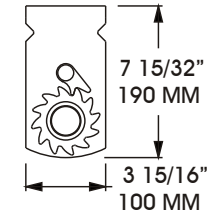

SUB FOR: ANCRA 43565-15,  
KINEDYNE 3820, MULTIPRENS 1760

SUB FOR: ANCRA 43565-12,  
KINEDYNE 5820, MULTIPRENS 1765

**NOTE:** FOR LOAD SECURING ONLY. **NOT FOR LIFTING.**  
ALL WINCH AND STRAP ASSEMBLIES SHOULD BE  
INSPECTED FOR FRAYS, CUTS, OR DAMAGED  
HARDWARE BEFORE AND AFTER USING.

**WORKING LOAD LIMIT (WLL):** 5,000 LBS / 2,267 KG  
**BREAK STRENGTH (BS):** 15,000 LBS / 6,800 KG  
DESIGNED TO MEET OR EXCEED WSTDA T-3 STANDARD.



Securing Your Containers. Protecting Your Cargo.



# FLATBED WINCH BARS

## STANDARD

**MODEL 2903-2700**

HIGH STRENGTH TIP

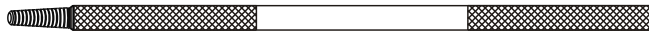

GROOVED TIP  
FOR BETTER GRIP

KNURLED HANDLE GRIPS

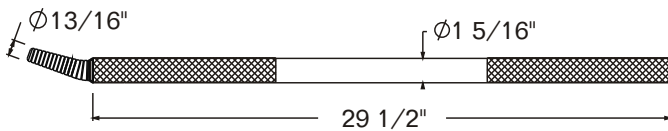
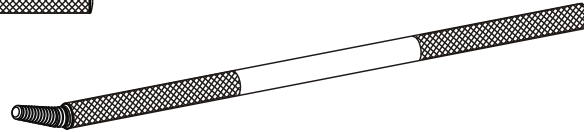

CHROME PLATED

NOT TO BE USED AS A CHEATER BAR  
TO TIGHTEN CHAIN LOAD BINDERS

**SUB FOR:** ANCRA 42313-17,  
MULTIPRENS 4101, KINEDYNE 37031

**MATERIAL:** STEEL

**FINISH:** CHROME (CH)

**WEIGHT:** 4.7 LBS / 2.13 Kg

## COMBINATION BOX END

**MODEL 2903-6339-B**

**MODEL 2903-6339-C**

HIGH STRENGTH TIP



KNURLED HANDLE GRIPS

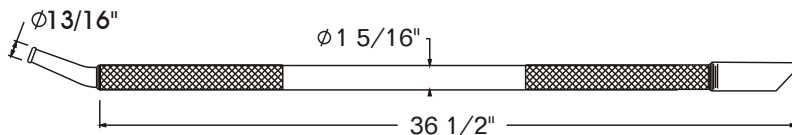
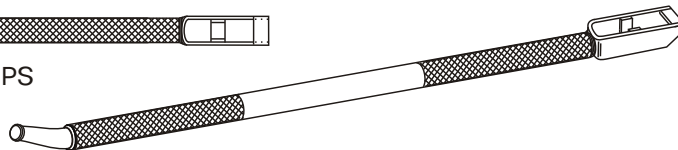

AVAILABLE BLACK PAINTED OR CHROME

**SUB FOR:** KINEDYNE 10032 BL & 10033 CH,  
ANCRA 42313-12 BL,  
MULTIPRENS 4001 CH & 4003 BL

**MATERIAL:** STEEL

**FINISH:** BLACK(BL), CHROME(CH)

**WEIGHT:** 6.75 LBS / 3.06 Kg

## COMBINATION

**MODEL 2903-6345-B**

**MODEL 2903-6345-C**

HIGH STRENGTH TIP

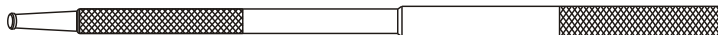

KNURLED HANDLE GRIPS

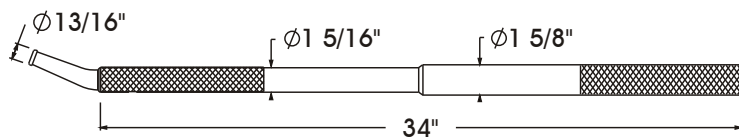
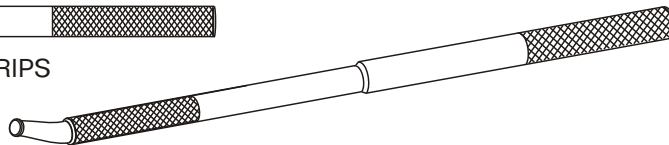

AVAILABLE BLACK PAINTED OR CHROME

**SUB FOR:** ANCRA 42313-19 CH  
& 42313-20 BL,  
KINEDYNE 37033 CH

**MATERIAL:** STEEL

**FINISH:** BLACK (BL)

OR CHROME (CH)

**WEIGHT:** 7.45 LBS / 3.38 Kg

# FLATBED WINCH STRAPS

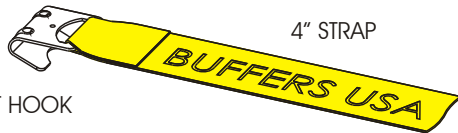

FLAT HOOK

4" STRAP

**WORKING LOAD LIMIT (WLL):** 5,400 LBS / 2,450 KG  
**BREAK STRENGTH (BS):** 16,200 LBS / 7,350 KG

**27 FT. WITH FLAT HOOK** **MODEL 2904-2805**

**SUB FOR:** ANCRA 43795-10-27P,  
KINEDYNE 422721 AND MULTIPRENS 2042-27

**30 FT. WITH FLAT HOOK** **MODEL 2904-2806**

**SUB FOR:** ANCRA 43795-10-30P,  
KINEDYNE 423021 AND MULTIPRENS 2042-30

**40 FT. WITH FLAT HOOK** **MODEL 2904-6004**

**46 FT. WITH FLAT HOOK** **MODEL 2904-6005**

**73 FT. WITH FLAT HOOK** **MODEL 2904-6007**



DELTA RING

4" STRAP

**WORKING LOAD LIMIT (WLL):** 5,400 LBS / 2,450 KG  
**BREAK STRENGTH (BS):** 16,200 LBS / 7,350 KG

**27 FT. WITH DELTA RING** **MODEL 2904-2807**

**SUB FOR:** ANCRA 43795-11-27P,  
KINEDYNE 422710 AND MULTIPRENS 2041-27

**30 FT. WITH DELTA RING** **MODEL 2904-2808**

**SUB FOR:** ANCRA 43795-11-30P,  
KINEDYNE 423010 AND MULTIPRENS 2041-30



DELTA RING  
WITH GRAB HOOK

4" STRAP

**WORKING LOAD LIMIT (WLL):** 5,400 LBS / 2,450 KG  
**BREAK STRENGTH (BS):** 16,200 LBS / 7,350 KG

**27 FT. WITH GRAB HOOK** **MODEL 2904-2809**

**SUB FOR:** ANCRA 43795-14-27P,  
KINEDYNE 422750 AND MULTIPRENS 2044-27

**30 FT. WITH GRAB HOOK** **MODEL 2904-2810**

**SUB FOR:** ANCRA 43795-14-30P,  
KINEDYNE 423050 AND MULTIPRENS 2044-30

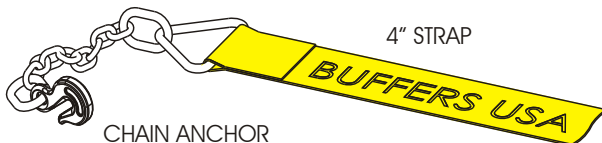

CHAIN ANCHOR

4" STRAP

**WORKING LOAD LIMIT (WLL):** 5,400 LBS / 2,450 KG  
**BREAK STRENGTH (BS):** 16,200 LBS / 7,350 KG

**27 FT. WITH CHAIN ANCHOR** **MODEL 2904-2811**

**SUB FOR:** ANCRA 43795-15-27P,  
KINEDYNE 422740 AND MULTIPRENS 2043-27

**30 FT. WITH CHAIN ANCHOR** **MODEL 2904-2812**

**SUB FOR:** ANCRA 43795-15-30P,  
KINEDYNE 423040 AND MULTIPRENS 2043-30



HALF TWISTED  
SEWN LOOP

4" STRAP

**WORKING LOAD LIMIT (WLL):** 5,400 LBS / 2,450 KG  
**BREAK STRENGTH (BS):** 16,200 LBS / 7,350 KG

**27 FT. WITH SEWN LOOP** **MODEL 2904-2813**

**SUB FOR:** ANCRA 43795-13-27,  
KINEDYNE 423030 AND MULTIPRENS 2040-27

**30 FT. WITH SEWN LOOP** **MODEL 2904-2814**

**SUB FOR:** ANCRA 43795-13-30,  
KINEDYNE 423030 AND MULTIPRENS 2040-30

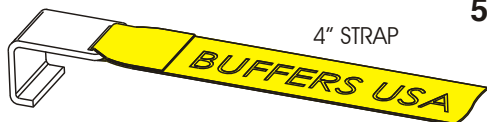

FLAT CONTAINER HOOK  
FOR ROLL-OFF REFUSE CONTAINERS

4" STRAP

**WORKING LOAD LIMIT (WLL):** 5,400 LBS / 2,450 KG  
**BREAK STRENGTH (BS):** 16,200 LBS / 7,350 KG

**5 FT. WITH FLAT CONTAINER HOOK** **MODEL 2904-6079**

**NOTE:** FOR LOAD SECURING ONLY, **NOT FOR LIFTING.** ALL WINCH AND STRAP ASSEMBLIES SHOULD BE INSPECTED FOR FRAYS, CUTS, OR DAMAGED HARDWARE BEFORE AND AFTER USING.

DESIGNED TO MEET OR EXCEED WSTDA T-1 STANDARD.



Securing Your Containers. Protecting Your Cargo.



# FLATBED CORNER AND WEBBING PROTECTORS

**MODEL 2904-6094**

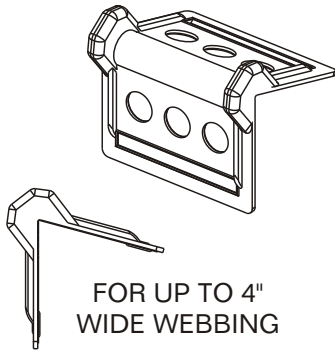
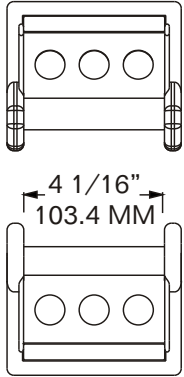

**MATERIAL:** PLASTIC **FINISH:** COLOR WHITE  
**WEIGHT:** 0.16 LB / 0.072 Kg

**MODEL 2904-6095**

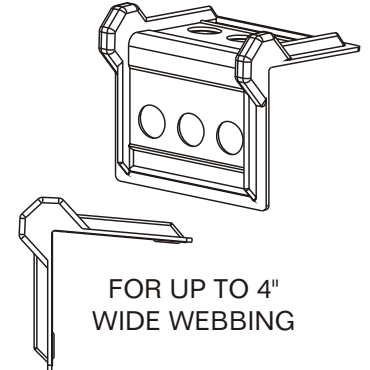
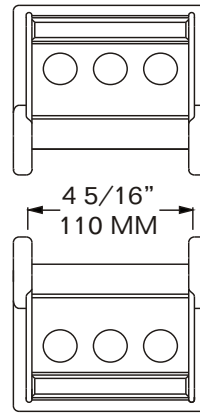

**MATERIAL:** PLASTIC **FINISH:** COLOR RED  
**WEIGHT:** 0.23 LBS / 0.105 Kg

**MODEL 2904-6096**

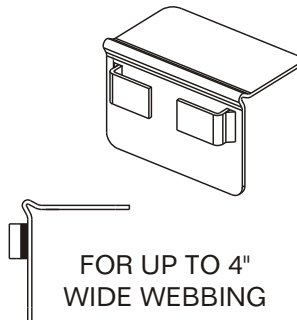
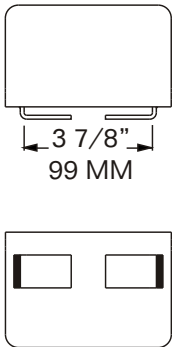

**MATERIAL:** STEEL **FINISH:** ZINC PLATED  
**WEIGHT:** 1.2 LB / 0.54 Kg

**MODEL 2904-6097**

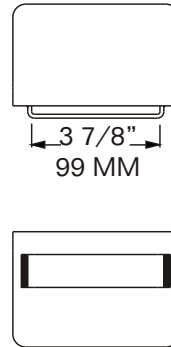

**MATERIAL:** STEEL **FINISH:** ZINC PLATED  
**WEIGHT:** 1.2 LBS / 0.54 Kg

**MODEL 2904-6098**

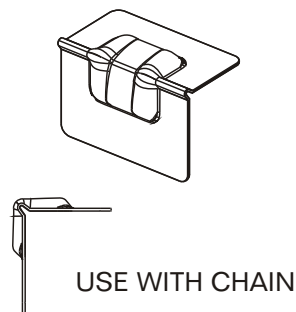
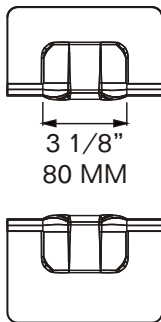

**MATERIAL:** STEEL **FINISH:** ZINC PLATED  
**WEIGHT:** 1.2 LB / 0.54 Kg

**MODEL 2904-6099**

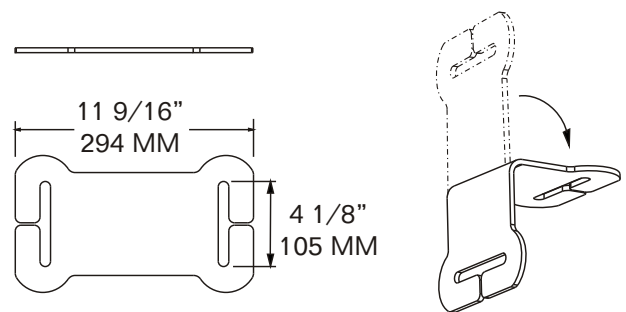

**MATERIAL:** BLACK RUBBER  
**FINISH:** SELF COLOR  
**WEIGHT:** 0.46 LBS / .21Kg

# TRAILER LOGISTICS STRAPS (RATCHET)

SPRING LOADED E/A CLIP

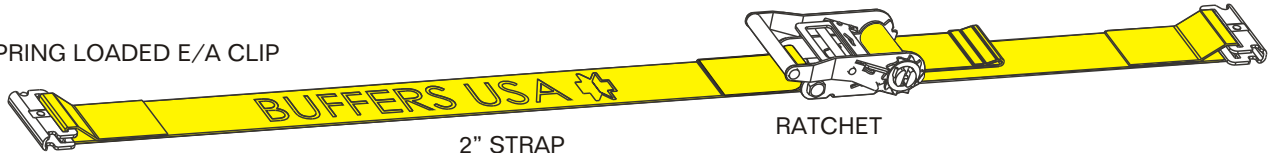

2" STRAP

RATCHET

**FITS E AND A SERIES TRACKS**

**WORKING LOAD LIMIT (WLL):** 1,000 LBS / 453.6 Kg  
**MIN BREAK STRENGTH (BS):** 3,000 LBS / 1,360.8 Kg

MODEL	DESCRIPTION	COLOR	WEIGHT
<b>2907-6018</b>	2 IN. X 12 FT. WITH SPRING LOADED E/A CLIP	YELLOW	2.1 LBS / 0.95 Kg
<b>2907-6019</b>	2 IN. X 16 FT. WITH SPRING LOADED E/A CLIP	GRAY	2.3 LBS / 1.04 Kg
<b>2907-6020</b>	2 IN. X 20 FT. WITH SPRING LOADED E/A CLIP	BLUE	2.5 LBS / 1.13 Kg

3 PC E/A CLIP

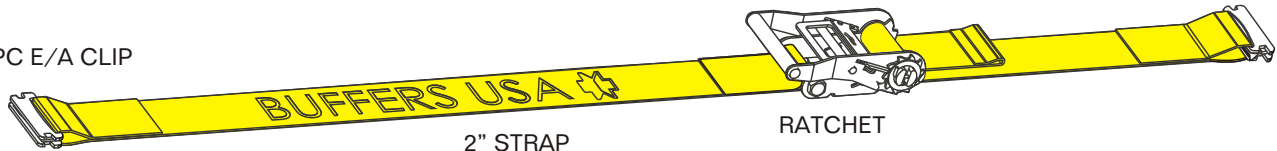

2" STRAP

RATCHET

**FITS E AND A SERIES TRACKS**

**WORKING LOAD LIMIT (WLL):** 1,000 LBS / 453.6 Kg  
**MIN BREAK STRENGTH (BS):** 3,000 LBS / 1,360.8 Kg

MODEL	DESCRIPTION	COLOR	WEIGHT
<b>2907-6021</b>	2 IN. X 12 FT. WITH E/A CLIP	YELLOW	2.0 LBS / 0.91 Kg
<b>2907-6022</b>	2 IN. X 16 FT. WITH E/A CLIP	GRAY	2.2 LBS / 1.0 Kg
<b>2907-6023</b>	2 IN. X 20 FT. WITH E/A CLIP	BLUE	2.4 LBS / 1.09 Kg

BUTTERFLY F-CLIP

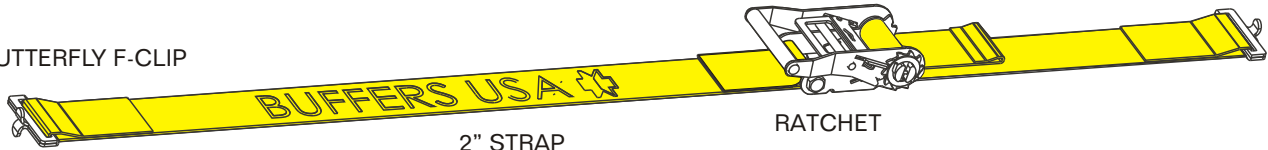

2" STRAP

RATCHET

**FITS F SERIES TRACKS**

**WORKING LOAD LIMIT (WLL):** 500 LBS / 227 Kg  
**MIN BREAK STRENGTH (BS):** 1,500 LBS / 680 Kg

MODEL	DESCRIPTION	COLOR	WEIGHT
<b>2907-6024</b>	2 IN. X 12 FT. WITH BUTTERFLY F-CLIP	YELLOW	1.85 LBS / 0.84 Kg
<b>2907-6025</b>	2 IN. X 16 FT. WITH BUTTERFLY F-CLIP	GRAY	2.05 LBS / 0.93 Kg
<b>2907-6026</b>	2 IN. X 20 FT. WITH BUTTERFLY F-CLIP	BLUE	2.25 LBS / 1.02 Kg

PLATE HOOK AND SPRING LOADED E/A CLIP COMBINATION

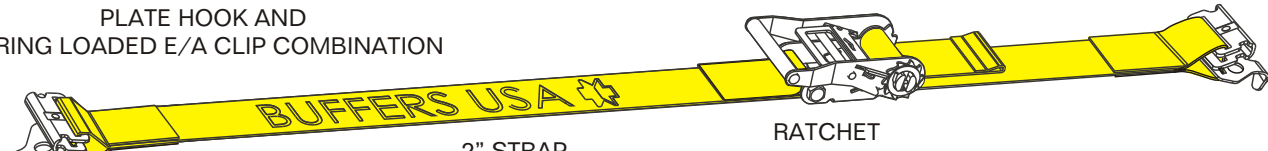

2" STRAP

RATCHET

**FITS E, A, AND F SERIES TRACKS**

**WORKING LOAD LIMIT (WLL):** 735 LBS / 373 Kg  
**MIN BREAK STRENGTH (BS):** 2,200 LBS / 998 Kg

MODEL	DESCRIPTION	COLOR	WEIGHT
<b>2907-6027</b>	2 IN. X 12 FT. WITH PLATE HOOK & SPRING LOADED E/A CLIP	YELLOW	2.55 LBS / 1.16 Kg
<b>2907-6028</b>	2 IN. X 16 FT. WITH PLATE HOOK & SPRING LOADED E/A CLIP	GRAY	2.75 LBS / 1.25 Kg
<b>2907-6029</b>	2 IN. X 20 FT. WITH PLATE HOOK & SPRING LOADED E/A CLIP	BLUE	2.95 LBS / 1.34 Kg



Securing Your Containers. Protecting Your Cargo.

# TRAILER LOGISTICS STRAPS (CAMBUCKLE)

SPRING LOADED E/A CLIP

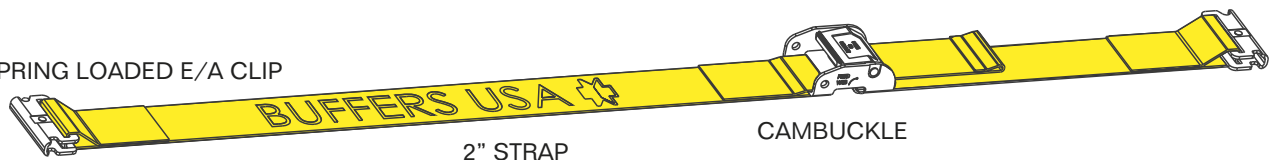

2" STRAP

CAMBUCKLE

**FITS E AND A SERIES TRACKS**

**WORKING LOAD LIMIT (WLL):** 835 LBS / 379 Kg  
**MIN BREAK STRENGTH (BS):** 2,500 LBS / 1,134 Kg

MODEL NO	DESCRIPTION	COLOR	WEIGHT
<b>2907-6030</b>	2 IN. X 12 FT. WITH SPRING LOADED E/A CLIP	YELLOW	1.75 LBS / 0.79 Kg
<b>2907-6031</b>	2 IN. X 16 FT. WITH SPRING LOADED E/A CLIP	GRAY	1.92 LBS / 0.87 Kg
<b>2907-6032</b>	2 IN. X 20 FT. WITH SPRING LOADED E/A CLIP	BLUE	2.09 LBS / 0.95 Kg

3 PC E/A CLIP

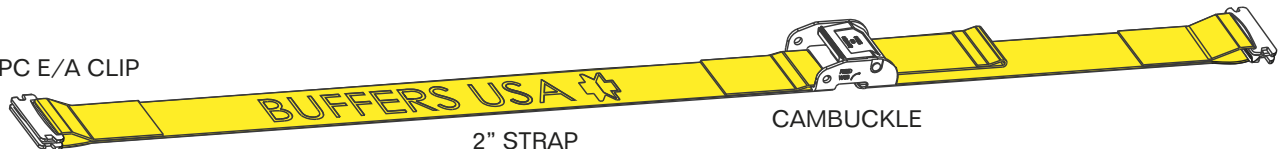

2" STRAP

CAMBUCKLE

**FITS E AND A SERIES TRACKS**

**WORKING LOAD LIMIT (WLL):** 835 LBS / 379 Kg  
**MIN BREAK STRENGTH (BS):** 2,500 LBS / 1,134 Kg

MODEL	DESCRIPTION	COLOR	WEIGHT
<b>2907-6033</b>	2 IN. X 12 FT. WITH E/A CLIP	YELLOW	1.65 LBS / 0.75 Kg
<b>2907-6034</b>	2 IN. X 16 FT. WITH E/A CLIP	GRAY	1.83 LBS / 0.83 Kg
<b>2907-6035</b>	2 IN. X 20 FT. WITH E/A CLIP	BLUE	2.00 LBS / 0.91 Kg

BUTTERFLY F-CLIP

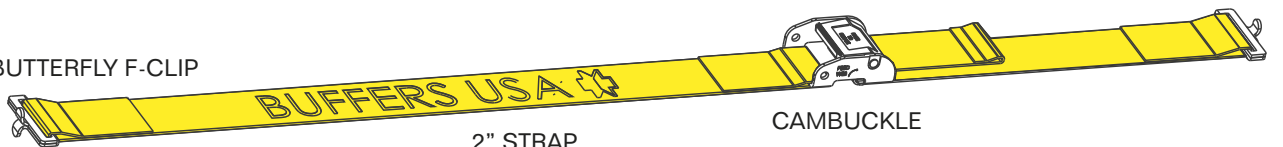

2" STRAP

CAMBUCKLE

**FITS F SERIES TRACKS**

**WORKING LOAD LIMIT (WLL):** 500 LBS / 227 Kg  
**MIN BREAK STRENGTH (BS):** 1,500 LBS / 680 Kg

MODEL	DESCRIPTION	COLOR	WEIGHT
<b>2907-6036</b>	2 IN. X 12 FT. WITH BUTTERFLY F-CLIP	YELLOW	1.45 LBS / 0.66 Kg
<b>2907-6037</b>	2 IN. X 16 FT. WITH BUTTERFLY F-CLIP	GRAY	1.62 LBS / 0.74 Kg
<b>2907-6038</b>	2 IN. X 20 FT. WITH BUTTERFLY F-CLIP	BLUE	1.80 LBS / 0.82 Kg

PLATE HOOK

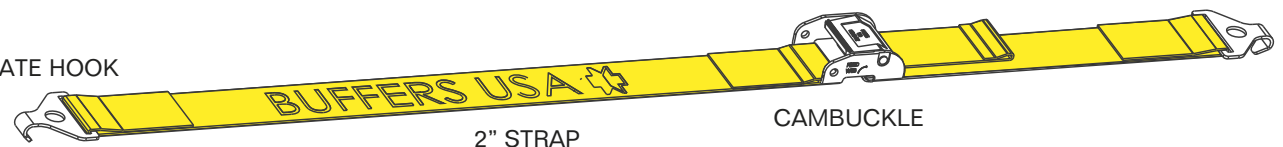

2" STRAP

CAMBUCKLE

**FITS F SERIES TRACKS**

**WORKING LOAD LIMIT (WLL):** 735 LBS / 373 Kg  
**MIN BREAK STRENGTH (BS):** 2,200 LBS / 998 Kg

MODEL	DESCRIPTION	COLOR	WEIGHT
<b>2907-6039</b>	2 IN. X 12 FT. WITH PLATE HOOK	YELLOW	1.65 LBS / 0.75 Kg
<b>2907-6040</b>	2 IN. X 16 FT. WITH PLATE HOOK	GRAY	1.83 LBS / 0.83 Kg
<b>2907-6041</b>	2 IN. X 20 FT. WITH PLATE HOOK	BLUE	2.00 LBS / 0.91 Kg



Securing Your Containers. Protecting Your Cargo.

# TRAILER LOGISTICS STRAPS (TIE OFFS)

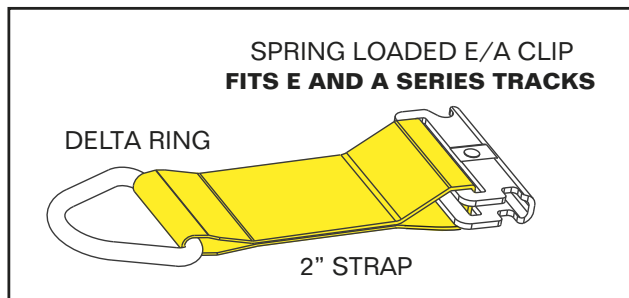

**MODEL 2907-6044**

**2 INCH X 6 INCH TIE OFF WITH  
DELTA RING AND SPRING LOADED E/A CLIP**

**WORKING LOAD LIMIT (WLL):** 1,000 LBS / 454 Kg  
**MIN BREAK STRENGTH (BS):** 3,000 LBS / 1,361 Kg  
**COLOR:** YELLOW  
**WEIGHT:** 0.4 LBS / 0.18 Kg

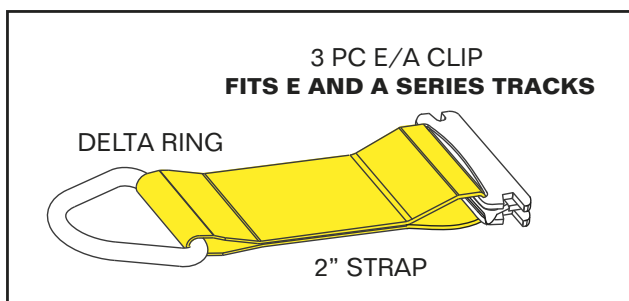

**MODEL 2907-6045**

**2 INCH X 6 INCH TIE OFF WITH  
DELTA RING AND 3 PC E/A CLIP**

**WORKING LOAD LIMIT (WLL):** 1,000 LBS / 454 Kg  
**MIN BREAK STRENGTH (BS):** 3,000 LBS / 1,361 Kg  
**COLOR:** YELLOW  
**WEIGHT:** 0.3LBS / 0.14 Kg

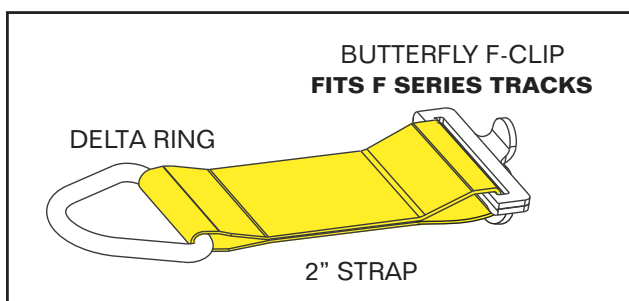

**MODEL 2907-6046**

**2 INCH X 6 INCH TIE OFF WITH  
DELTA RING AND BUTTERFLY F-CLIP**

**WORKING LOAD LIMIT (WLL):** 500 LBS / 227 Kg  
**MIN BREAK STRENGTH (BS):** 1,500 LBS / 680 Kg  
**COLOR:** YELLOW  
**WEIGHT:** 0.25LBS / 0.11 Kg